

MCI Series

Specification

Product Name	High Frequency Chip Ceramic Inductor
Series	MCI Series
Size	EIAJ 0603-1005



High Frequency Chip Ceramic Inductor (MCI Series)

Engineering Specification

This product belongs to the industrial grade standard, not the vehicle gauge product! Can not use auto parts, if the customer is not expressly informed and privately used to auto parts, produce any consequences, the original is not responsible for after-sales service, thank you!

■ FEATURES

- Particular ceramic material and coil structure provide high frequency application range up to 10GHz.
- Small size and low profile.
- Available in various sizes.
- Excellent solderability and heat resistance.

■ APPLICATIONS

RF and wireless communication, information technology equipment which includes computer, telecommunications, radar detectors, automotive electronics, cellular phones, pagers, audio equipment, PDAs, keyless remote system and low-voltage power supply modules.

■ SHAPES AND DIMENSIONS

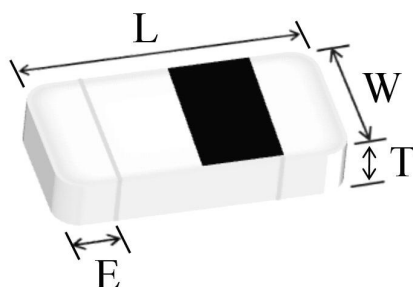

TYPE	060303 (EIA 0201)	100505 (EIA 0402)
L	0.6±0.03	1.0±0.10
W	0.3±0.03	0.5±0.10
T	0.3±0.03	0.5±0.10
E	0.10~0.20	0.10~0.30
Unit	mm	

■ PART NUMBER CODE

<u>MCI</u>	<u>0603</u>	<u>HQ</u>	<u>1N0</u>	<u>□</u>	<u>H</u>	<u>B</u>	<u>P</u>
1	2	3	4	5	6	7	8

- 1 Series Name
- 2 Dimensions L*W
- 3 HQ : material code
- 4 Inductance(nH) : N means Decimal point , ex : 1.0 nH = 1N0
- 5 Tolerance : B = $\pm 0.1\text{nH}$, C = $\pm 0.2\text{nH}$, S = $\pm 0.3\text{nH}$, G = $\pm 2\%$, H = $\pm 3\%$, J = $\pm 5\%$
- 6 Mark : H = 1/8 Mark , M = 1/4 Mark , N = No Mark
- 7 Soldering : Green Parts , B= Lead-Free for whole chip
- 8 Packaging : P - Paper tape, 7" reel

■ GENERAL TECHNICAL DATA

Operating temperature range: - 55°C ~ +125°C
Storage Condition: Less than 40°C and 70% RH
Storage Time: 6 months Max.
Soldering method: Reflow

■ TEST INSTRUMENTS CONDITIONS

Agilent E4991A RF Impedance
Material Analyzer with fixture 16197A or equivalent
Agilent 4338B Milliohm meter
Test Level : 500mV

■ PART NUMBER AND CHARACTERISTICS TABLE

Part No.	Inductance (nH)	Inductance Tolerance	Q (Min.)	Freq. (MHz)	DCR(Ω) Max.	S.R.F (MHz) Min.	Rated Current (mA) Max.	
MCI0603HQ Series								
MCI0603HQ0N3_HBP	0.3	B	4	100	0.07	10,000	850	
MCI0603HQ0N4_HBP	0.4		4	100	0.07	10,000	850	
MCI0603HQ0N5_HBP	0.5		4	100	0.08	10,000	800	
MCI0603HQ0N6_HBP	0.6		4	100	0.08	10,000	800	
MCI0603HQ0N7_HBP	0.7		4	100	0.09	10,000	750	
MCI0603HQ0N8_HBP	0.8		4	100	0.10	10,000	750	
MCI0603HQ0N9_HBP	0.9		4	100	0.10	10,000	750	
MCI0603HQ1N0_HBP	1.0		B, C, S	4	100	0.14	10,000	600
MCI0603HQ1N1_HBP	1.1			4	100	0.14	10,000	600
MCI0603HQ1N2_HBP	1.2	4		100	0.14	10,000	600	
MCI0603HQ1N3_HBP	1.3	4		100	0.14	10,000	600	
MCI0603HQ1N4_HBP	1.4	4		100	0.18	10,000	550	
MCI0603HQ1N5_HBP	1.5	4		100	0.18	10,000	550	
MCI0603HQ1N6_HBP	1.6	4		100	0.18	10,000	500	
MCI0603HQ1N7_HBP	1.7	4		100	0.19	10,000	500	
MCI0603HQ1N8_HBP	1.8	4		100	0.19	10,000	500	
MCI0603HQ1N9_HBP	1.9	4		100	0.20	10,000	450	
MCI0603HQ2N0_HBP	2.0	4		100	0.20	10,000	450	
MCI0603HQ2N1_HBP	2.1	4		100	0.20	10,000	450	
MCI0603HQ2N2_HBP	2.2	4		100	0.22	10,000	450	
MCI0603HQ2N3_HBP	2.3	4		100	0.22	10,000	450	
MCI0603HQ2N4_HBP	2.4	4		100	0.24	10,000	450	
MCI0603HQ2N5_HBP	2.5	4		100	0.24	10,000	450	
MCI0603HQ2N6_HBP	2.6	4		100	0.25	10,000	450	
MCI0603HQ2N7_HBP	2.7	5		100	0.25	10,000	450	
MCI0603HQ2N9_HBP	2.9	5		100	0.28	9,500	450	
MCI0603HQ3N0_HBP	3.0	5		100	0.28	9,500	450	
MCI0603HQ3N1_HBP	3.1	5		100	0.28	9,500	450	
MCI0603HQ3N2_HBP	3.2	5	100	0.30	9,500	450		
MCI0603HQ3N3_HBP	3.3	5	100	0.30	9,500	450		

Part No.	Inductance (nH)	Inductance Tolerance	Q (Min.)	Freq. (MHz)	DCR(Ω) Max.	S.R.F (MHz) Min.	Rated Current (mA) Max.
MCI0603HQ Series							
MCI0603HQ3N4_HBP	3.4	B , C , S	5	100	0.30	8,000	400
MCI0603HQ3N5_HBP	3.5		5	100	0.30	8,000	400
MCI0603HQ3N6_HBP	3.6		5	100	0.30	8,000	400
MCI0603HQ3N7_HBP	3.7		5	100	0.30	8,000	400
MCI0603HQ3N8_HBP	3.8		5	100	0.30	6,500	400
MCI0603HQ3N9_HBP	3.9		5	100	0.30	6,500	400
MCI0603HQ4N3_HBP	4.3		5	100	0.40	6,500	350
MCI0603HQ4N7_HBP	4.7		5	100	0.40	6,500	350
MCI0603HQ5N1_HBP	5.1		5	100	0.40	6,500	350
MCI0603HQ5N6_HBP	5.6		5	100	0.40	6,000	350
MCI0603HQ6N2_HBP	6.2		5	100	0.44	6,000	300
MCI0603HQ6N8_HBP	6.8	H , J	5	100	0.50	5,400	300
MCI0603HQ7N5_HBP	7.5		5	100	0.53	4,800	300
MCI0603HQ8N2_HBP	8.2		5	100	0.55	4,800	250
MCI0603HQ9N1_HBP	9.1		5	100	0.62	4,500	250
MCI0603HQ10N_HBP	10		5	100	0.65	4,500	250
MCI0603HQ12N_HBP	12		5	100	0.70	3,700	250
MCI0603HQ15N_HBP	15		5	100	0.80	2,200	250
MCI0603HQ18N_HBP	18		5	100	0.90	2,200	200
MCI0603HQ22N_HBP	22		5	100	1.20	2,000	150
MCI0603HQ27N_HBP	27		4	100	1.80	1,800	140
MCI0603HQ33N_HBP	33	J	4	100	2.10	1,700	120
MCI0603HQ39N_HBP	39		4	100	2.40	1,500	120
MCI0603HQ47N_HBP	47		4	100	2.80	1,300	100
MCI0603HQ56N_HBP	56		4	100	3.00	1,100	80
MCI0603HQ68N_HBP	68		4	100	2.66	1,100	80
MCI0603HQ82N_HBP	82		4	100	3.37	1,000	70
MCI0603HQR10_HBP	100		4	100	3.74	900	60

** For special part number which is not shown in the above table, please refer to appendix.

Part No.	Inductance (nH)	Inductance Tolerance	Q (Min.)	Freq. (MHz)	DCR(Ω) Max.	S.R.F (MHz) Min.	Rated Current (mA) Max.	
MCI1005HQ Series								
MCI1005HQ0N3_HBP	0.3	B	8	100	0.08	10,000	380	
MCI1005HQ0N4_HBP	0.4		8	100	0.08	10,000	380	
MCI1005HQ0N5_HBP	0.5		8	100	0.08	10,000	380	
MCI1005HQ0N6_HBP	0.6		8	100	0.08	10,000	380	
MCI1005HQ0N7_HBP	0.7		8	100	0.08	10,000	380	
MCI1005HQ0N8_HBP	0.8		8	100	0.08	10,000	380	
MCI1005HQ1N0_HBP	1.0	B, C, S	8	100	0.08	10,000	380	
MCI1005HQ1N1_HBP	1.1		8	100	0.08	10,000	380	
MCI1005HQ1N2_HBP	1.2		8	100	0.09	10,000	380	
MCI1005HQ1N3_HBP	1.3		8	100	0.09	10,000	380	
MCI1005HQ1N5_HBP	1.5		8	100	0.10	10,000	380	
MCI1005HQ1N6_HBP	1.6		8	100	0.10	10,000	380	
MCI1005HQ1N8_HBP	1.8		8	100	0.12	10,000	380	
MCI1005HQ2N0_HBP	2.0		8	100	0.12	10,000	380	
MCI1005HQ2N2_HBP	2.2		8	100	0.13	10,000	380	
MCI1005HQ2N4_HBP	2.4		8	100	0.13	10,000	380	
MCI1005HQ2N7_HBP	2.7		8	100	0.16	6,000	380	
MCI1005HQ3N0_HBP	3.0		8	100	0.16	6,000	380	
MCI1005HQ3N3_HBP	3.3		8	100	0.16	6,000	300	
MCI1005HQ3N6_HBP	3.6		8	100	0.20	6,000	300	
MCI1005HQ3N9_HBP	3.9		8	100	0.20	6,000	300	
MCI1005HQ4N3_HBP	4.3		8	100	0.20	6,000	300	
MCI1005HQ4N7_HBP	4.7		8	100	0.20	6,000	300	
MCI1005HQ5N1_HBP	5.1		8	100	0.23	5,300	300	
MCI1005HQ5N6_HBP	5.6		8	100	0.23	4,500	300	
MCI1005HQ6N2_HBP	6.2		8	100	0.25	4,500	300	
MCI1005HQ6N8_HBP	6.8		G, H, J	8	100	0.25	4,500	300
MCI1005HQ7N5_HBP	7.5			8	100	0.28	4,200	300
MCI1005HQ8N2_HBP	8.2			8	100	0.28	3,700	300
MCI1005HQ9N1_HBP	9.1			8	100	0.30	3,400	300
MCI1005HQ10N_HBP	10	8		100	0.30	3,400	300	
MCI1005HQ12N_HBP	12	8		100	0.45	3,000	300	

Part No.	Inductance (nH)	Inductance Tolerance	Q (Min.)	Freq. (MHz)	DCR(Ω) Max.	S.R.F (MHz) Min.	Rated Current (mA) Max.
MCI1005HQ Series							
MCI1005HQ13N_HBP	13	G , H , J	8	100	0.50	3,000	300
MCI1005HQ15N_HBP	15		8	100	0.55	2,500	300
MCI1005HQ18N_HBP	18		8	100	0.65	2,200	300
MCI1005HQ22N_HBP	22		8	100	0.70	1,900	300
MCI1005HQ24N_HBP	24		8	100	0.70	1,700	300
MCI1005HQ27N_HBP	27		8	100	0.80	1,700	300
MCI1005HQ33N_HBP	33		8	100	0.90	1,600	200
MCI1005HQ39N_HBP	39		8	100	1.00	1,200	200
MCI1005HQ47N_HBP	47		8	100	1.10	1,100	200
MCI1005HQ56N_HBP	56		8	100	1.10	1,000	200
MCI1005HQ68N_HBP	68		8	100	1.20	800	200
MCI1005HQ82N_HBP	82	H , J	8	100	1.30	600	200
MCI1005HQR10_HBP	100	J	8	100	1.60	600	200
MCI1005HQR12_HBP	120		8	100	1.60	600	150
MCI1005HQR15_HBP	150		8	100	3.20	550	140
MCI1005HQR18_HBP	180		8	100	3.70	500	130
MCI1005HQR22_HBP	220		8	100	4.20	450	120
MCI1005HQR27_HBP	270		8	100	4.80	400	110

** For special part number which is not shown in the above table, please refer to appendix.

■ TYPICAL ELECTRICAL CHARACTERISTIC

L vs. Frequency

MCI 0603HQ Series

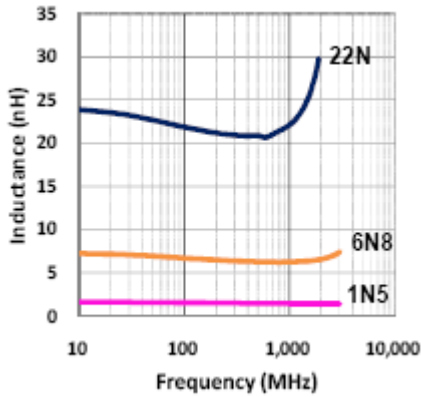

MCI 1005HQ Series

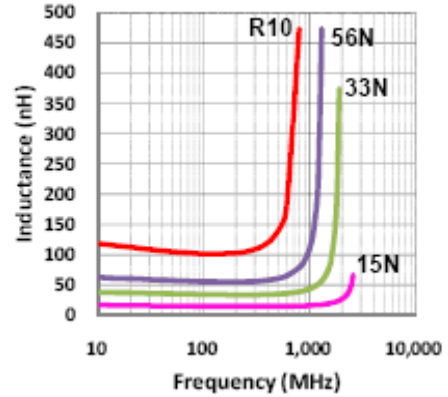

Q vs. Frequency

MCI 0603HQ Series

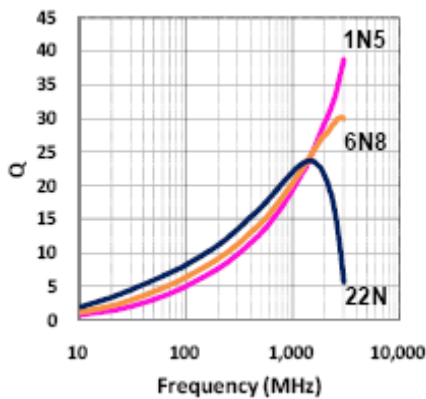

MCI 1005HQ Series

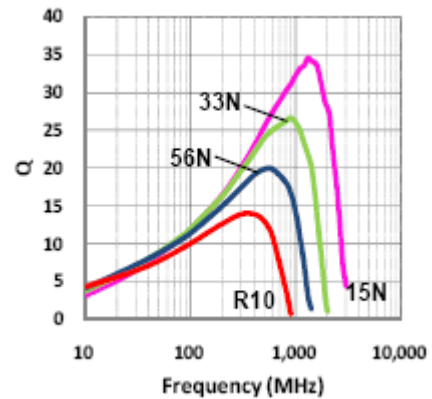

Z vs. Frequency

MCI 0603HQ Series

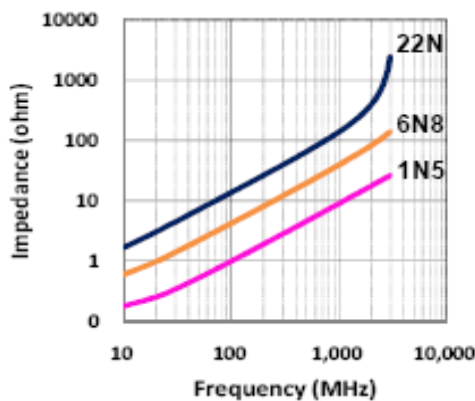

MCI 1005HQ Series

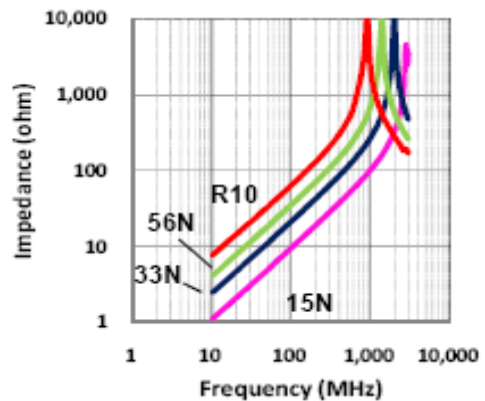

■ PACKAGING SPECIFICATIONS

➤ Type : Paper Carrier

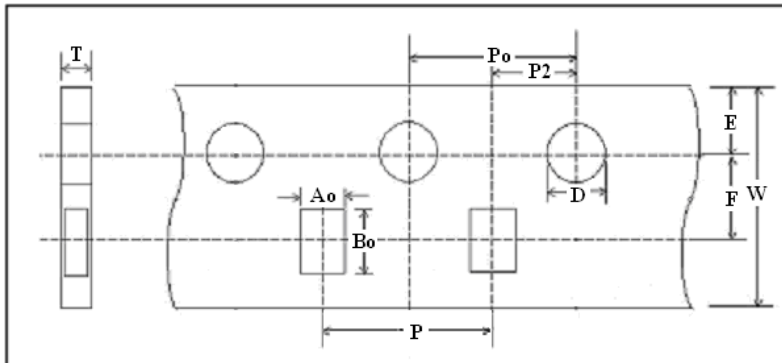

➤ Taping Dimension

(mm)	0603	1005
Symbol	PAPER	PAPER
W	8.00 ± 0.10	8.00±0.10
P	2.00 ± 0.05	2.00±0.05
E	1.75 ± 0.05	1.75±0.05
F	3.50 ± 0.05	3.50±0.05
D	1.55 ± 0.05	1.55±0.05
Po	4.00 ± 0.10	4.00±0.10
P2	2.00 ± 0.05	2.00±0.05
Ao	0.36 ± 0.02	0.62±0.03
Bo	0.66 ± 0.02	1.12±0.03
T	0.42 ± 0.02	0.60±0.03

■ REEL DIMENSION

Unit : mm

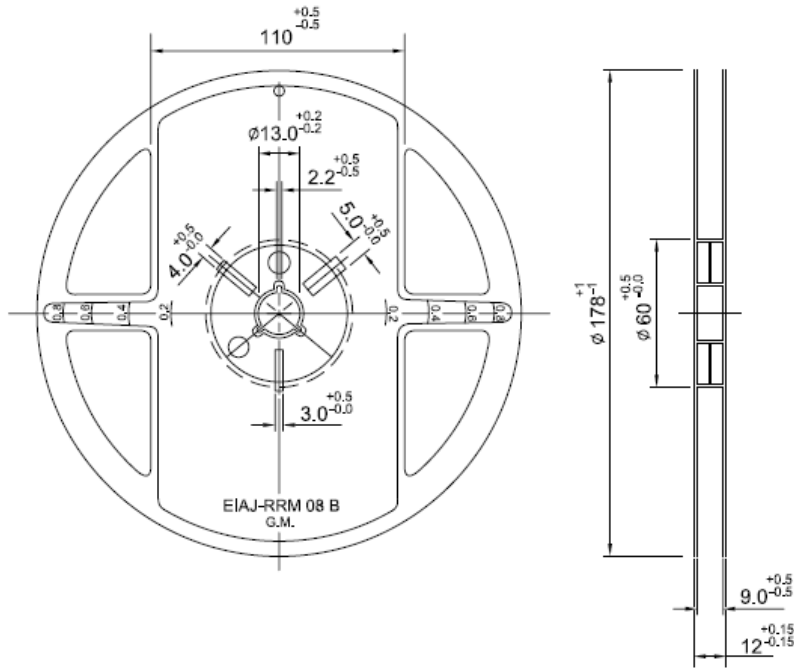

7" Reel Packaging Quantity		
PART SIZE (EIA SIZE)	0603 (0201)	1005 (0402)
Qty.(pcs)	15,000	10,000
BOX	5 reels / inner box	5 reels / inner box

■ RECOMMENDED SOLDERING CONDITIONS

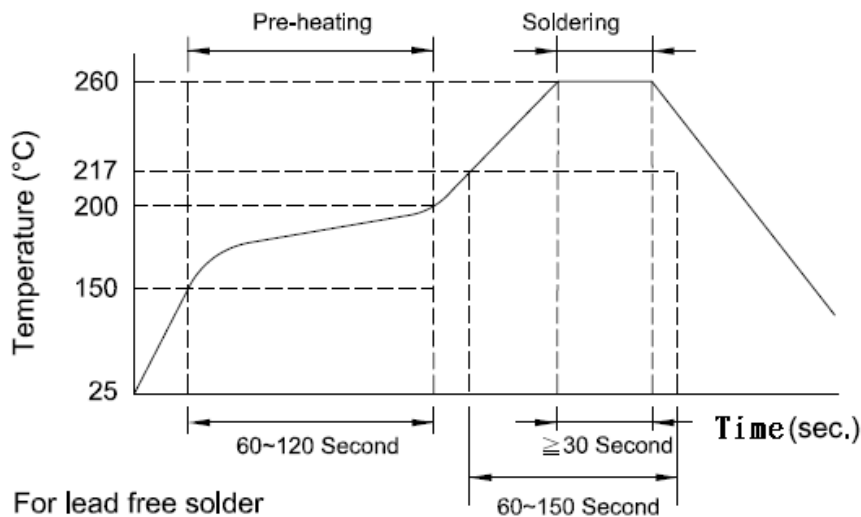

■ **LAND PATTERNS REFLOW SOLDERING**

Solder land information :

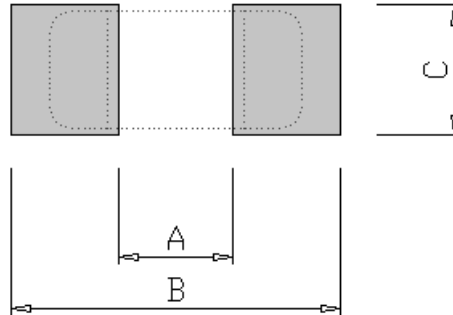

Size(mm)	A	B	C
0603 (EIA 0201)	0.20 ~ 0.30 (0.008 ~ 0.012)	0.80 ~ 0.90 (0.031 ~ 0.035)	0.20 ~ 0.30 (0.008 ~ 0.012)
1005 (EIA 0402)	0.40 (0.016)	1.40 ~ 1.50 (0.055 ~ 0.059)	0.40 ~ 0.50 (0.016 ~ 0.020)

■ **RELIABILITY AND TEST CONDITION**

Item	Test Condition	Requirements
Temperature Cycle	<ol style="list-style-type: none"> 1. Temperature : -55 ~ +125°C 2. Cycle : 100 cycles 3. Dwell time : 30minutes 4. Measurement : at ambient temperature 24 hrs after test completion 	<ol style="list-style-type: none"> 1. No mechanical damage 2. Inductance value should be within ± 10 % of the initial value 3. Q vale should be within ± 20% of the initial value
Operational Life	<ol style="list-style-type: none"> 1. Temperature: 85 ± 5°C 2. Testing time: 1000 hrs 3. Applied current: Full rated current 4. Measurement: At ambient temperature 24 hours after test completion 	<ol style="list-style-type: none"> 1. No mechanical damage 2. Inductance value should be within ± 10 % of the initial value 3. Q vale should be within ± 20% of the initial value

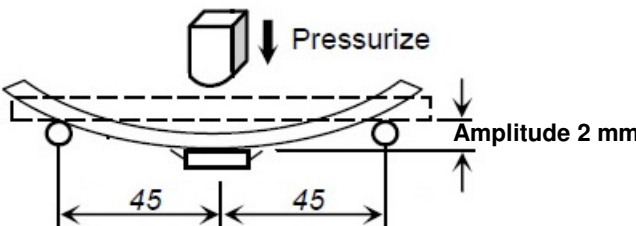
Item	Test Condition	Requirements
Biased Humidity	1. Temperature : $40^{\circ}\text{C} \pm 2^{\circ}\text{C}$ 2. Humidity : 90 ~ 95 % RH 3. Test time : 1000 hrs 4. Apply current : full rated current 5. Measurement : at ambient temperature 24 hrs after test completion	1. No mechanical damage 2. Inductance value should be within $\pm 10\%$ of the initial value 3. Q vale should be within $\pm 20\%$ of the initial value
Resistance to Solder Heat	1. Solder temperature : $260 \pm 5^{\circ}\text{C}$ 2. Flux : Rosin 3. DIP time : 10 ± 1 sec	1. More than 95 % of terminal electrode should be covered with new solder 2. Inductance value should be within $\pm 10\%$ of the initial value 3. Q vale should be within $\pm 20\%$ of the initial value
Solderability	1. Solder temperature : $235 \pm 5^{\circ}\text{C}$ 2. Flux : Rosin 3. DIP time : 5 ± 1 sec	1. More than 95 % of terminal electrode should be covered with new solder 2. No mechanical damage
Bending Strength	1. Solder the chip to test jig then apply a force in the direction shown in below. 2. The soldering shall be done with the reflow method and shall be conducted with care so that the soldering is uniform and free of defects such as heat shock. <div style="text-align: center;">  </div>	No mechanical damage

■ **NOTE**

The storage atmosphere must be free of gas containing sulfur and chlorine. Also, avoid exposing the product to saline moisture. If the product is exposed to such atmospheres, the terminals will oxidize and solderability will be affected.